

WKC4.221T-2/TEB

Actuator and Sensor Cable, PVC – Connection Cable

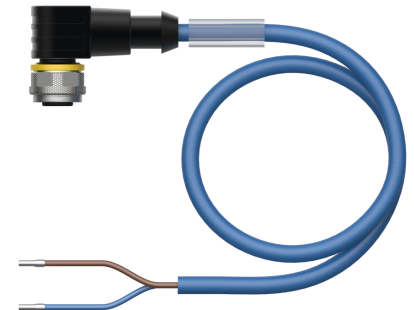
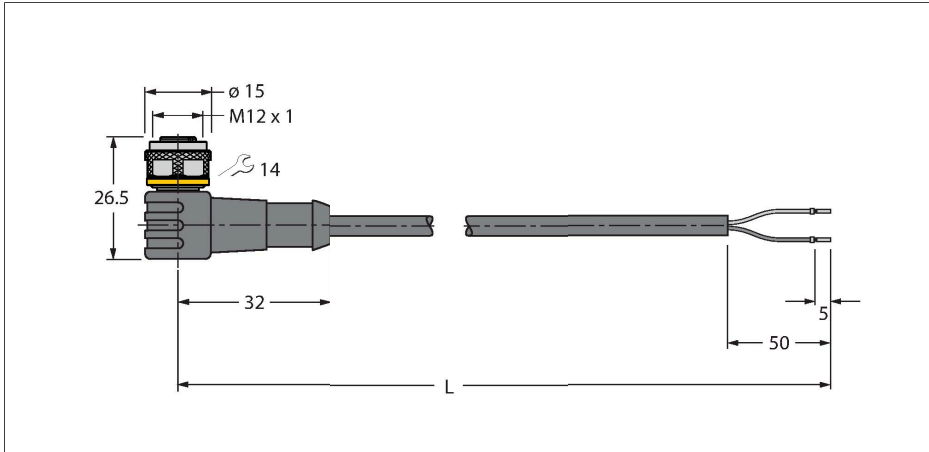

Technical data

Type	WKC4.221T-2/TEB
ID	6628427
Connector A	Female, M12 × 1, Angled, A-coded
Number of pins	2
Contacts	Brass, CuZn, Gold-plated
Contact carriers	Plastic, TPU, Black
Connector body	Plastic, TPU, Black
Coupling nut/screw	Brass, CuZn, Nickel-plated
Seal	Plastic, FPM/FKM
Mechanical lifespan	> 100 Mating cycles
Pollution degree	3
Protection class	IP67, IP69K, Only in screwed condition
Cable	
Cable diameter	Ø 4.4 mm ±0.20
Cable length	2 m
Cable jacket	PVC, Blue
Core insulation	PVC
Core cross-section	2 x 0.5 mm ²
Arrangement of strands	64 x 0.1 mm
Core colors	BN, BU
Electrical properties at +20 °C	
Rated voltage	250 V
Test voltage	2000 V
Current	4 A
Insulation resistance	> 30.5 MΩ/km
forward resistance	max. 57 Ω/km
Nom. capacitance	0.89 pF/m

Features



- Female M12, angled, 2-pin
- Jacket material: PVC
- Jacket color: blue
- Flame retardant
- Resistant to chemicals and oils
- Resistant to microbes and hydrolysis
- LABS free
- Protection class: IP67, IP69K
- Cable length: 2.0 m

Cable Cross-Section

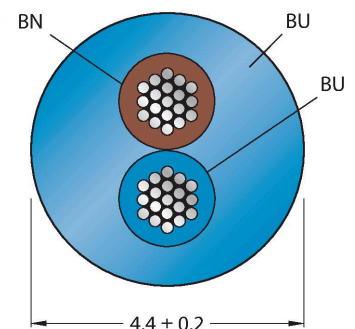

Contact assignment

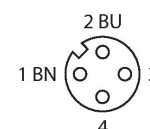

Technical data

Nom. Inductance	1.25 mH/km
Mechanical and chemical properties	
Bending radius (stationary installation)	$\geq 5 \times \varnothing$
Bending radius (flexible use)	$\geq 10 \times \varnothing$
Ambient temperature (fixed)	-40...+105 °C
Ambient temperature (mobile)	-5...+80 °C
Approvals	cULus

Circuit Diagram

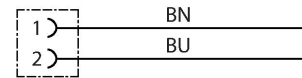

Accessories

TORQUE-WRENCH-SET-AS	6936170	BLANK-LABEL-FOR-CORDSETS-TEL-TXL	6936206
Torque wrench set; handles with adjustable torque 0.4-1.0 Nm, torque wrench for M8 (SW9), fork wrench for M12 (SW 14)		Label for TEL and TXL cables, length: 18 mm, height: 4 mm, material: polycarbonate (PC), color: white, halogen-free and flame-retardant	

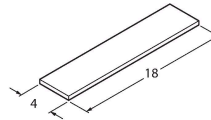

Accessories

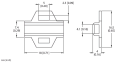
Dimension drawing	Type	ID	
	LABEL-HOLDER-FLEX-PVC	100048170	PVC label holder for identification of extension cables (TEL/TXL product series); for cable diameters: min. 5 mm; dimensions 4 × 18 mm; delivery unit: 50 pcs. per package